

Original operating instructions

Beverage cooler

Read the operating instructions before switching on for the first time

Page 10

EN

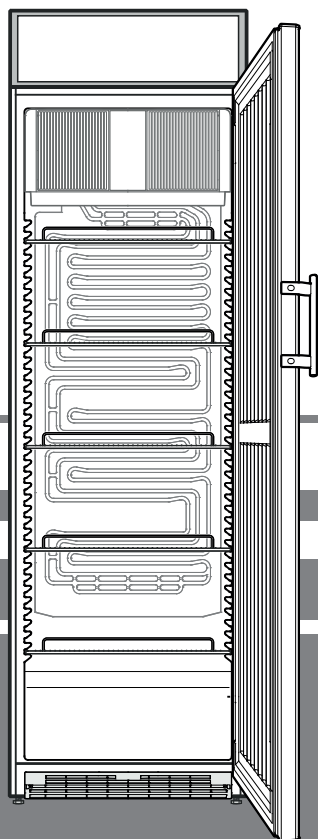

FKDv 4211



7085 794-01

LIEBHERR

Content

Priority of warnings.....	10
EPREL database.....	10
Safety instructions and warnings.....	10
Symbols on the appliance.....	11
Intended use.....	11
Foreseeable incorrect use.....	11
Declaration of conformity.....	11
Noise emissions from the appliance.....	11
Climate class.....	12
Description of the appliance.....	12
Setting up.....	12
Appliance dimensions.....	13
Electrical connection.....	13
Switching the appliance on and off.....	13
Setting the temperature.....	13
Cooling.....	13
Safety lock.....	13
Interior light.....	14
Display light.....	14
Defrosting.....	14
Cleaning.....	14
Malfunctions.....	14
Shutting your appliance down.....	14
Disposal notes.....	14
Additional information:.....	15
Changing over door hinges.....	15

Priority of warnings

 DANGER	identifies a situation involving direct danger which, if not obviated, may result in death or severe bodily injury.
 WARNING	identifies a dangerous situation which, if not obviated, may result in death or severe bodily injury.
 CAUTION	identifies a dangerous situation which, if not obviated, may result in minor or medium bodily injury.
NOTICE	identifies a dangerous situation which, if not obviated, may result in damage to property.
Note	identifies useful information and tips.

EPREL database

As from 1 March 2021, information about energy labelling and ecodesign requirements will be available in the European product database (EPREL). You can access the product database using the following link: <https://eprel.ec.europa.eu/>. You will be asked to enter the model identifier. You will find the model identifier on the type plate.

Safety instructions and warnings

- **WARNING:** do not seal ventilation openings on the appliance housing or enclosure. 

- **WARNING:** only use the mechanical devices or other aids recommended by the manufacturer to help speed up the defrosting process.

- **WARNING:** do not damage the refrigerant circuit.

- **WARNING:** do not use any electrical devices in the refrigerator compartment which do not comply with the design recommended by the manufacturer.

- **WARNING:** the mains cable must not be damaged while installing the appliance.

- **WARNING:** multi-sockets or distributor strips and other electronic devices (such as halogen transformers) must not be positioned and operated at the rear of appliances.

- **WARNING:** danger of injury through electric shock. There are live parts under the cover. Only have the interior LED light replaced or repaired by customer service staff or trained personnel.

- **WARNING:** risk of injury from the LED lamp. The light intensity of the LED light complies with laser class RG 2. If the cover is defective, do not look directly at the light through optical lenses from close distance. This may damage your eyes.

- **WARNING:** this appliance must be secured as described in the operating instructions to rule out any potential risks due to its instability.

- This appliance can be used by children of 8 years old and over, and also by persons with restricted physical, sensory or mental capacity or lack of experience and knowledge, if they are supervised or have been instructed on safe use of the appliance and understand the resulting risks. Children must not be allowed to play with the appliance. Cleaning and user maintenance must not be carried out by children without supervision.

- Do not store any explosive substances, such as aerosol containers with flammable propellant gas, inside the appliance.

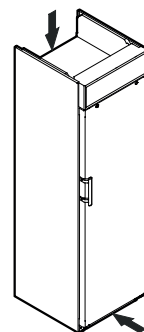

- To prevent injury and damage to property, the appliance should only be installed by two people.

- After unpacking it, check the appliance for signs of damage. Contact the supplier if it is damaged. Do not connect the appliance to the mains power supply.



- Avoid prolonged skin contact with cold surfaces (e.g. chilled/frozen products). If necessary, take safety action (e.g. gloves).
- All repairs and work on the appliance may only be carried out by customer service personnel or other trained personnel. The same applies to changing the mains power cable.
- Only carry out repair and other work on the appliance when the mains plug has visibly been disconnected.
- Only install, connect and dispose of the appliance as described in these operating instructions.
- In the event of a fault, pull out the plug or switch off the fuse.
- When disconnecting the appliance from the mains, pull on the plug. Do not pull on the cable.
- Ensure that food which has been stored for too long is not consumed. Dispose of food which has been stored for too long properly.
- Do not use the interior LED light to light the room. The interior LED light is only designed to illuminate the interior of the appliance.
- Do not allow naked flames or ignition sources to enter the appliance.
- Alcoholic drinks or other vessels containing alcohol should be sealed tightly for storage.

Symbols on the appliance

	The symbol can be located on the compressor. It refers to the oil in the compressor and indicates the following danger: swallowing or inhaling can be fatal. This is only relevant for recycling. There is no danger in normal operation.
	Warning about inflammable substances.
	A sticker to this effect may be applied to the rear of the appliance. It refers to the foampadded panels in the door and/or the housing. This is only relevant for recycling. Do not remove the sticker.

Intended use

This professional refrigeration appliance is designed for storing, presentation and sale of chilled packed food and drink. It may be used for the presentation of packed food and drink in a commercial environment and in retail sales outlets. It is designed for the removal of chilled goods by customers.

The appliance is designed for use in enclosed rooms. All other types of use are not permitted.

Foreseeable incorrect use

Do not use the appliance for the following applications:

- Storage and cooling of medicines, blood plasma, laboratory preparations or similar substances and products subject to the Medical Devices Directive 2007/47/EC.
- Use in potentially explosive atmospheres.
- Use outdoors or in areas where it is exposed to splash water or damp conditions.

Incorrect use of the appliance will result in damaging or spoiling the goods stored in it.

Declaration of conformity

The refrigerant circuit has been tested for leaks. The appliance complies with the relevant safety regulations and EU Directives 2006/42/EG, 2014/30/EU, 2009/125/EG and 2011/65/EU.

Noise emissions from the appliance

The noise level while the appliance is operating is below 70 dB(A) (relative noise level 1 pW).

Climate class

The climate class [X] specifies the ambient conditions in which the appliance can be operated safely.

The climate class [Y] and temperature class [Z] define the maximum outline conditions in which the appliances will operate perfectly.

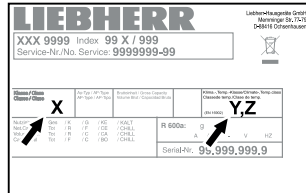

The climate rating is indicated on the type plate.

[X] Climate class	Max. room temperature	Max. relative humidity
3	25 °C	60 %
4	30 °C	55 %
5	40 °C	40 %
7	35 °C	75 %

The minimum room temperature at the place of installation is 10°C.

[Y] Climate class	Temperature [°C]	Relative humidity [%]
CC1	25,0	60
CC2	32,2	65
CC3	40,6	75

Recommended temperature setting:

[Z] Temperature class	Temperature setting [°C]
K1	3,5
K2	2,5
K3	-1,0
K4	+5,0

Description of the appliance

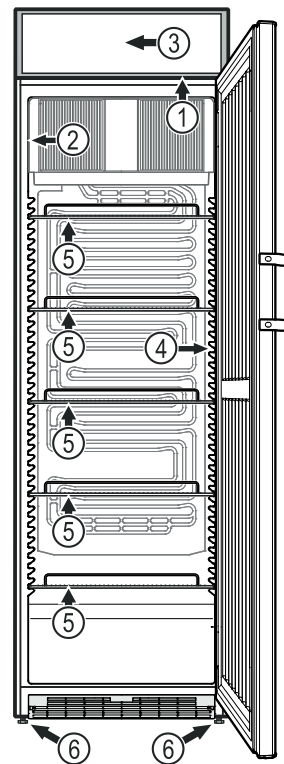

- (1) Temperature control
- (2) Type plate
- (3) Display light (LED light strip)
- (4) Interior light (LED light strip)
- (5) Grid shelves
- (6) Adjustable height feet

NOTICE

The maximum load per grid shelf is 45 kg.

Setting up

- Do not place the appliance in direct sunlight or near cookers, radiators and similar sources of heat.
- The floor on which the appliance stands should be horizontal and level. Compensate for uneven floors with the adjustable feet.
- There must be a gap of at least 20 cm between the upper edge of the appliance and the ceiling.
- The more coolant there is in the appliance, the larger the room in which the appliance is installed must be. If the room is too small, any leak may create a flammable mixture of gas and air. For each 8 g of coolant the installation space must be at least 1 m³. Information on the coolant is on the model plate inside the appliance.
- Always install the appliance directly against the wall.

Appliance dimensions

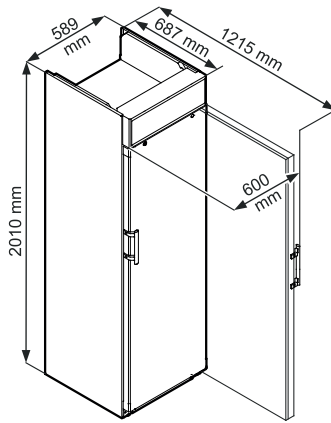

Remove transport lock

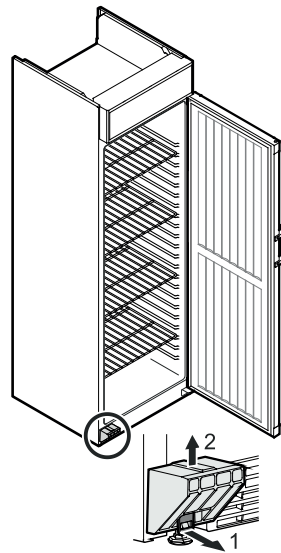

Setting the temperature

Set the temperature inside the appliance using the temperature control.

The nearer the temperature control is to the **max.** setting, the colder the interior temperature. Set the control between "0" and "max." as required.

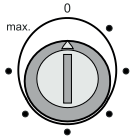

Note

The temperature in the warmest area of the interior may be higher than the temperature setting.

If the door is left open for a lengthy period, the temperature in the appliance's compartments may rise dramatically.

Electrical connection

Only operate the appliance with **alternating current (AC)**.

The permissible voltage and frequency are indicated on the type plate. The position of the type plate is shown in the section entitled **Description of the appliance**.

The socket must be properly earthed and protected by a fuse.

The tripping current of the fuse must be between 10 A and 16 A.

The socket must not be situated behind the appliance and must be easily accessible.

Do not connect the appliance using an extension cable or extension socket.

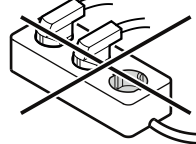

Do not use stand-alone inverters (conversion of direct current to alternating current/three-phase current) or energy-saving plugs. Risk of damage to the electronic control system!

Switching the appliance on and off

You are recommended to clean the interior of the appliance before switching it on for the first time (see **Cleaning**).

Switching the appliance on

Connect the appliance to the mains - the appliance is switched on.

Note

Once the mains plug has been inserted, the refrigeration unit may not come on until up to 8 minutes later. This is required to protect the electronic controls.

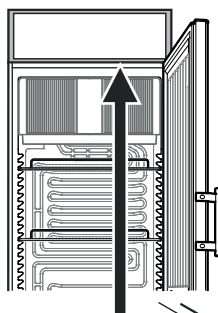

Switching the appliance off

Pull out the mains plug or set the temperature control to 0.

Note

When the temperature control is turned to "0", the refrigeration system is switched off, but the appliance is not completely disconnected from the mains.

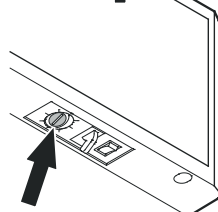

Cooling

The grid shelves can be moved to accommodate different height bottles or packages.

The ventilation slots on the inside must not be covered!

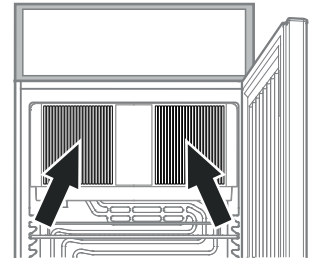

NOTICE

Store raw meat or fish in clean sealed containers on the bottom shelf of the refrigerator/freezer compartment so that it cannot come into contact with any other food or drip liquid onto it.

A failure to follow these instructions may result in the food being spoilt.

Safety lock

The lock in the appliance door is equipped with a safety mechanism.

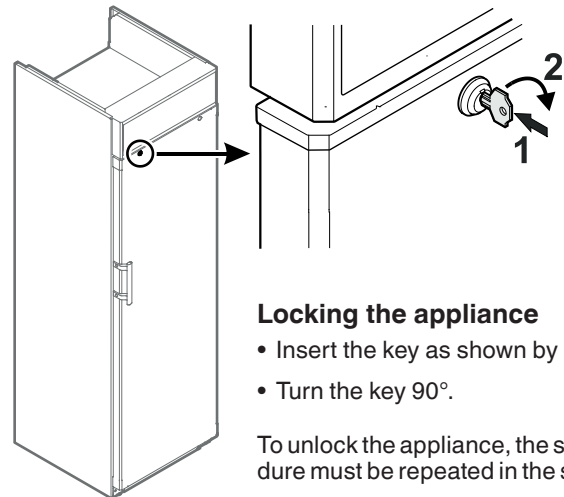

Locking the appliance

- Insert the key as shown by arrow 1.
- Turn the key 90°.

To unlock the appliance, the same procedure must be repeated in the same order.

Interior light

Display light

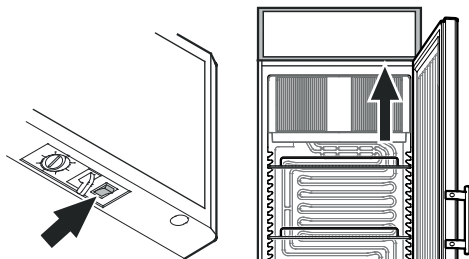

The light can be switched on and off by pressing the switch.

Defrosting

The refrigerator compartment defrosts automatically.

When operating at a very cold thermostat setting, the interior rear wall may ice up. In this case, the appliance must be defrosted manually.

• Pull out the mains plug!

- Remove the food from the appliance and store in a cool place.
- Leave the door of the appliance open while defrosting. After defrosting mop up the remaining water and clean the appliance.

Cleaning

⚠ WARNING

Before cleaning, always disconnect the appliance from the mains. Pull out the plug or switch off the fuse.

Surfaces which may come into contact with food and accessible drain systems must be cleaned at regular intervals.

⚠ CAUTION

Risk of damage to the appliance components and risk of injury due to hot steam.

Do not use steam cleaning equipment to clean the appliance.

- Clean the inside, equipment parts and outer walls with lukewarm water and a little detergent. Do not use chemical solvents or any cleaning agents containing sand or acid.
- Ensure that no cleaning water penetrates into the electrical components or ventilation grille.
- Dry all parts well with a cloth.
- The dust should be removed from the refrigeration unit and heat exchanger - metal grid at the back of the appliance - once a year.
- Do not damage or remove the type plate on the inside of the appliance. It is very important for servicing purposes.

Malfunctions

You may be able to rectify the following faults by checking the possible causes yourself:

• Appliance does not function:

- Is the appliance switched on?
- Is the plug correctly fitted in the mains socket?
- Is the fuse intact?

• The temperature is not low enough:

- Is the temperature setting correct (see "Setting the temperature")?
- Does the separately installed thermometer show the correct reading?
- Is the ventilation system working properly?
- Is the appliance set up too close to a heat source?

If none of the above causes apply and you cannot rectify the fault yourself, contact the nearest customer service department stating the type designation (1), service number (2) and appliance number (3) as indicated on the type plate.

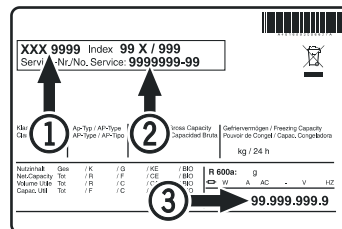

The position of the type plate is shown in the section entitled **Description of the appliance**.

Shutting your appliance down

If the appliance is left empty for a lengthy period, it must be switched off, defrosted, cleaned and dried and the door is to be left open to prevent mould formation.

The permissible room temperature for storing the appliance after decommissioning is between -10°C and +50°C.

Storing the appliance outside this temperature range can damage the appliance and cause it to malfunction.

Disposal notes

The appliance contains reusable materials and should be disposed of properly - not simply with unsorted household refuse. Appliances which are no longer needed must be disposed of in a professional and appropriate way, in accordance with the current local regulations and laws.



Do not damage the refrigerant circuit of an appliance that is no longer needed during its disposal.

This appliance contains inflammable gases in the refrigerant circuit and insulation foam.

Your local council or a waste disposal contractor can provide information about how to dispose of the appliance correctly.

Additional information:

- Food will remain fresh for longer if stored at the correct temperature. This can prevent having to discard food needlessly.
- If the condenser coil is not cleaned every year, it will significantly reduce the appliance's efficiency.
- The period during which spare parts, necessary for the repair of the refrigerating appliance with a direct sales function, are available is 10 years.
- The minimum duration of the guarantee of the refrigerating appliance with a direct sales function offered by the manufacturer, importer or authorised representative is 2 years.

Changing over door hinges

Door hinges should only be changed by a trained expert.

Changing the door hinges must be done by two people.

Important

The door must now be held secure by somebody.

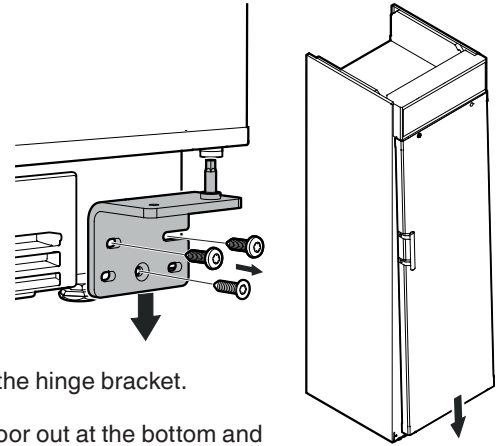

1.

Unscrew the hinge bracket.

Pull the door out at the bottom and lift off.

2.

Transfer door handle and plugs to the other side.

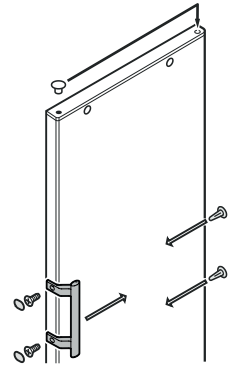

3.

Remove screw.

Insert key.

Turn key 90°.

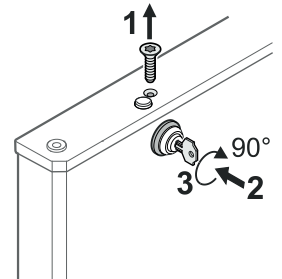

4.

Remove pin.

Turn lock.

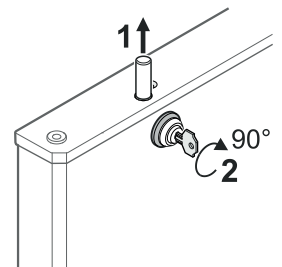

5.

Remove lock.

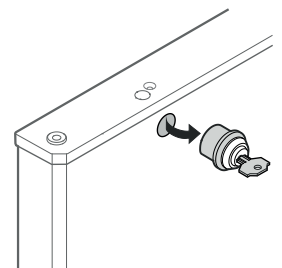

6.
Transfer covers to the opposite side.

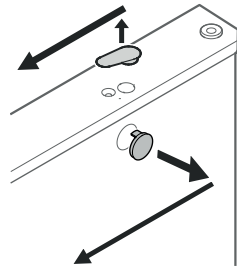

7.
Insert key.
Turn key 90°.

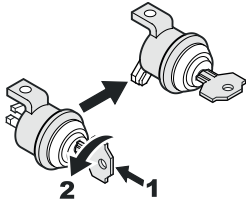

8.
Remove door latch, turn over and re-assemble.

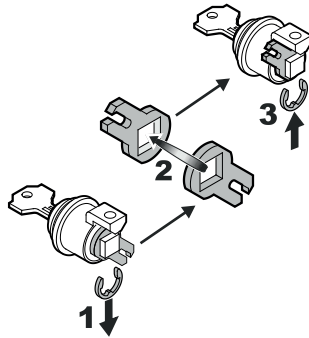

9.
Insert lock.

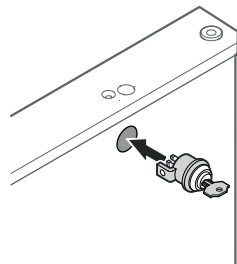

10.
Turn lock.
Insert pin.

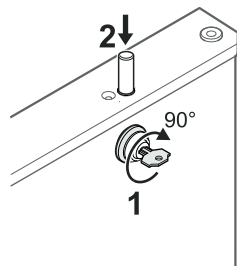

11.
Insert key.
Turn key 90°.
Insert screw.

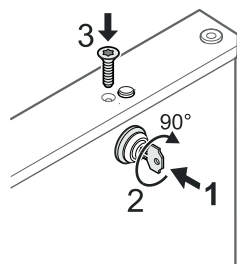

12.
Transfer hinge pin to the opposite side.

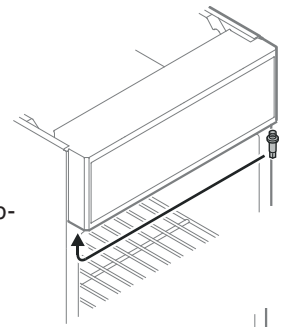

13.
Transfer cover plate to the opposite side.

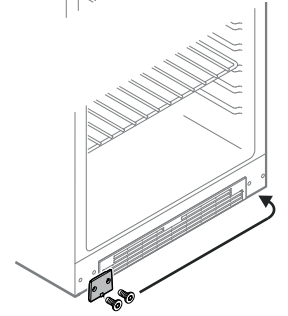

14.
Transfer pin on hinge bracket to the opposite side.

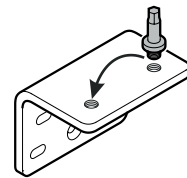

15.
Mount door on hinge pin and close.

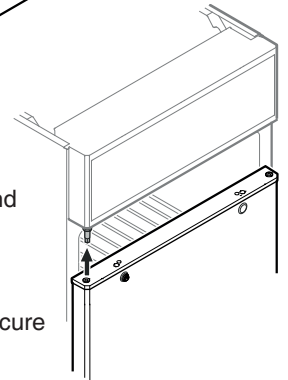

Important

The door must now be held secure by somebody.

16.
Insert hinge bracket in lower door mounting and screw into place.

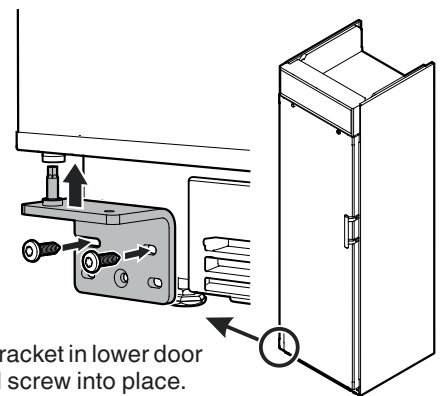

If the door is at an angle, adjust the angle.

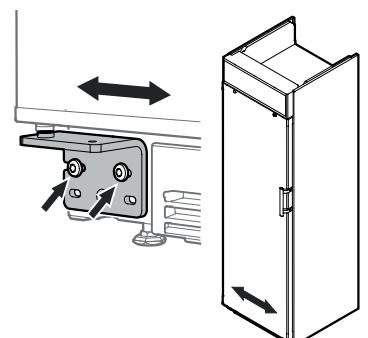



Liebherr-Hausgeräte GmbH
Memminger Straße 77-79
88416 Ochsenhausen
Germany
home.liebherr.com

