

CPF9GMR

Cooker size	90x60 cm
N. of cavities with energy label	1
Cavity heat source	ELECTRICITY
Hob type	Gas
Type of main oven	Thermo-ventilated
Cleaning system main oven	Vapor Clean
EAN code	8017709225742
Energy efficiency class	A+



Aesthetics











Design	Flush fit	Controls colour	Stainless steel
Command panel finish	Enamelled metal	No. of controls	8
Aesthetic	Portofino	Serigraphy colour	Black
Logo	Assembled st/steel	Display name	CompactScreen
Colour	Red	Door	With frame
Logo position	Facia below the oven	Glass type	Grey
Upstand	Yes	Handle	Smeg Portofino
Hob colour	Stainless steel	Handle Colour	coloured
Type of pan stands	Cast Iron	Storage compartment	Push pull
Type of control setting hob	Control knobs	Feet color	Black
Type of control knobs	Smeg Portofino	Plinth	Black

Programs / Functions main oven

No. of cooking functions 9

Traditional cooking functions

 Static	 Fan assisted	 Circulaire
 Turbo	 Eco	 Large grill
 Fan grill (large)	 Base	 Fan assisted base

Other functions



Defrost by time



Defrost by weight



Proving



Sabbath

Cleaning functions



Vapor clean

Automatic programs

20

Hob technical features

UR

Total no. of cook zones 6

Front left - Gas - 2UR (dual) - 4.20 kW

Rear left - Gas - AUX - 1.00 kW

Front centre - Gas - AUX - 1.00 kW

Rear centre - Gas - Semi Rapid - 1.80 kW

Front right - Gas - Semi Rapid - 1.80 kW

Rear right - Gas - Rapid - 3.00 kW

Type of gas burners Standard

Gas safety valves Yes

Automatic electronic ignition Yes

Burner caps Matt black enamelled

Main Oven Technical Features



No. of lights 2

Fan number 3

Net volume of the cavity 115 l

Gross volume, 1st cavity 129 l

Cavity material Ever Clean enamel

No. of shelves 5

Type of shelves Metal racks

Light type Halogen

Light Power 40 W

Cooking time setting Start and Stop

Light when oven door is open Yes

Door opening Flap down

Removable door Yes

Full glass inner door Yes

Removable inner door Yes

Total no. of door glasses 3

No. of thermo-reflective door glasses 2

Safety Thermostat Yes

Heating suspended when door is opened Yes

Cooling system Tangential

Usable cavity space dimensions (HxWxD) 371x724x418 mm

Temperature control Electronic

Lower heating element power 1700 W

Upper heating element - Power 1200 W

Grill element 1700 W

Large grill - Power 2900 W

Circular heating element - Power 1500 W

Grill type Electric

Tilting grill Yes

Soft Close system Yes

Options Main Oven

Timer	Yes	Minimum Temperature	50 °C
End of cooking acoustic alarm	Yes	Maximum temperature	280 °C

Accessories included for Main Oven & Hob

Cast iron wok support	1	40mm deep tray	1
TOP Oven grid with back stop	1	Grill mesh	1
20mm deep tray	1		

Electrical Connection

Electrical connection rating	3200 W	Frequency	50/60 Hz
Current	14 A	Terminal block	3 poles
Voltage	220-240 V	Plug	Not present
Power supply cable length	120 cm		

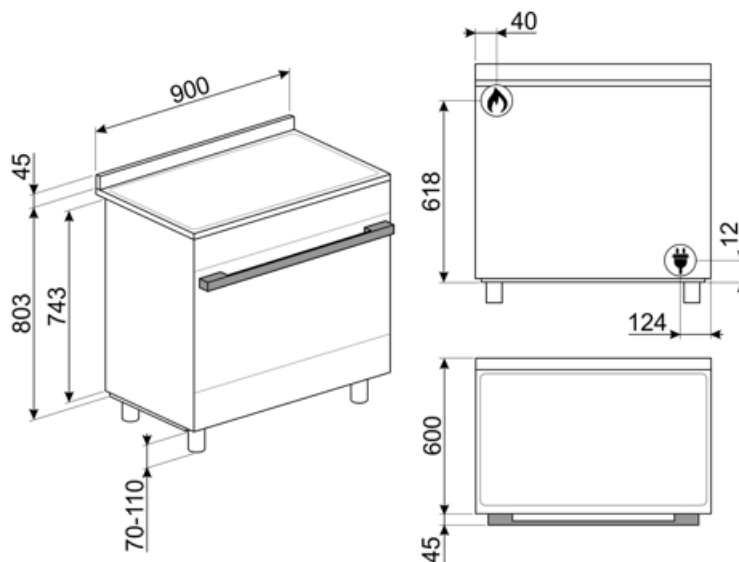

Compatible Accessories

AIRFRY9

Air fryer rack AIRFRY . Ideal for recreating traditional frying in the oven, but with fewer calories and less fat. It allows you to cook quickly and simply dishes such as French fries, fried vegetables and fish, ensuring perfect browning and crispiness.



BN920

Enamelled tray 90cm cavity, 20mm deep



GTP

Partially extractable telescopic guides (1 level), suitable for traditional ovens. Made in stainless steel, they guarantee stability and facilitate the smooth extraction of the trays.



KITC9X9-1

Splashback kit, st/steel, 90cm, suitable for Portofino Multifunction, Master and Sinfonia cookers

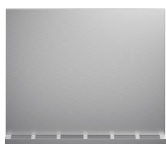

KITPAX

Height extension feet, stainless steel, (950mm) suitable for Master, Sinfonia and Portofino 90cm cookers (914-968mm); Height extension feet (900mm), st/steel, suitable for Concerto cookers with 850mm height (880-935mm)



KITPD

Height extension black feet (950 mm), black, suitable for Master, Sinfonia and Portofino 90cm (914-968mm); Height extension black feet (900 mm), black, suitable for Concerto cookers with 850mm height (880-935mm)



SFLK1

Child lock



WOKGHU

Cast iron WOK Support



BBQ9

teflon-coated aluminum grid for 90 cm cavity



BN940

Enamelled tray 90 cm, 40 mm deep



GTT

Totally extractable telescopic guides (1 level), suitable for traditional ovens. Made in stainless steel, they guarantee stability and facilitate the smooth extraction of the trays.



KITH95CPF9

Height extension kit with plinth, (950mm), three sides, black with feet, suitable for CPF9 Portofino and Sinfonia C9 cookers



KITPBX

Height reduction feet (850mm), st/steel, for Sinfonia and Master cookers (845-856mm)



PALPZ

Pizza shovel with folding handle. Dimensions L31.5 x H32.5 cm. Easy and convenient to use and store. Perfect for serving pizza, bread and savory pastries in a safe and professional way.







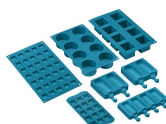









SMOLD



Set of 7 silicone moulds for ice creams, ice lollies, pralines, ice cubes or to portion food. Usable from -60°C to +230°C







Symbols glossary



- | | |
|--|---|
|  <p>Triple Fan Technology: The oven is equipped with an exclusive three fan system, which, combined with the increased power of the motors, enables excellent cooking performance. The two large side fans distribute the air around the outer perimeter of the cavity while the smaller central fan increases ventilation by creating a vertical vortex of heat. Accordingly, the temperature within the cavity is uniform, allowing food to be cooked evenly on all five levels, like in professional kitchens.</p> |  <p>Heavy duty cast iron pan stands: for maximum stability and strength.</p> |
|  <p>A+: Energy efficiency class A+ helps to save up to 10% energy compared to class A. Maximum performance with minimum consumption is guaranteed.</p> |  <p>Installation in column: Installation in column.</p> |
|  <p>Knobs control</p> |  <p>Air cooling system: to ensure a safe surface temperatures.</p> |
|  <p>Defrost by time: Manual defrost function. At the end of the set duration, the function stops.</p> |  <p>Defrost by weight: Automatic defrost function. You choose the type of food to defrost from the available categories (MEAT - FISH - BREAD - DESSERTS). After entering the weight of the food, the oven automatically defines the time required for proper defrosting.</p> |
|  <p>With a simple and intuitive interface, the COMPACTscreen provides a pleasant user experience, thanks to the interaction with the knobs.</p> |  <p>Triple glazed doors: Number of glazed doors.</p> |
|  <p>Ever Clean Enamel: Ever Clean enamel is applied electrostatically, corner to corner and edge to edge to prevent cracking or cracks over time. It is a particular pyrolytic enamel, resistant to acids which, in addition to being pleasantly bright, promotes greater cleaning of the oven walls, thanks to its lower porosity. It is baked at over 850 °C and slowly polymerized at a scientifically determined rate to ensure uniform depth and strength. Ever Clean enamel creates an impeccable finish both on the inside of the oven and on the trays, making the surfaces of the oven incredibly easy to maintain over time as it reduces the adhesion of fat during cooking.</p> |  <p>Fan assisted base: the mix of fan and lower heating element alone allows to finish cooking foods already cooked on the surface but not internally more quickly. This system is recommended to finish cooking foods that are already well cooked on the surface, but not internally, which therefore require a moderate higher heat. Ideal for any type of food.</p> |
|  <p>Fan assisted: Intense and homogeneous traditional cooking, also suitable for complex recipes. The fan is active and the heat comes from below and from above at the same time. Ventilated cooking ensures a faster and more homogeneous result, leaving fragrant foods outside and moister inside. Ideal for baked pasta, biscuits, roasts and cobblers.</p> |  <p>Static: Traditional cooking suitable for the preparation of one dish at a time. The fan is not active and the heat comes from below and from above at the same time. Static cooking is slower and more delicate, ideal in order to get well cooked and dry dishes even inside. Ideal for cooking all types of roasts, fatty meats, bread, filled cakes.</p> |



-  **Base:** the heat comes only from the bottom of the cavity. The fan is not active. Ideal for sweet and savory pies, cobblers and pizzas. Designed to complete cooking and make food more crunchy. This symbol in gas ovens indicates the gas burner.



 **Circulaire:** it is the perfect function for cooking all types of dishes in a more delicate way. The heat comes from the back of the oven and is distributed quickly and evenly. The fan is active. It is also ideal for cooking on multiple levels without mixing smells and flavors.
-  **ECO:** low energy consumption cooking: this function is particularly suitable for cooking on a single shelf with low energy consumption. It is recommended for all types of food except those that can generate a lot of moisture (for example vegetables). To achieve maximum energy savings and reduce time, it is recommended to put the food in the oven without preheating the cooking compartment.



 **Grill:** Very intense heat coming only from above from a double heating element. The fan is not active. Provides excellent grilling and gratinating results. Used at the end of cooking, it gives a uniform browning to dishes.
-  **Fan grill:** very intense heat coming only from above from a double heating element. The fan is active. It allows the optimal grilling of thickest meats. Ideal for large cuts of meat.



 **Turbo:** the heat comes from 3 directions: above, below and from the back of the oven. The fan is active. It allows quick cooking, even on several shelves without mixing the aromas. Ideal for large volumes or foods that require intense cooking.
-  **All glass inner door:** All glass inner door, a single flat surface which is simple to keep clean.



 **The inner door glass:** can be removed with a few quick movements for cleaning.
-  **Side lights:** Two opposing side lights increase visibility inside the oven.

 **Automatic opening:** some models have Automatic opening door when the cycle is finished which is a perfect solution for handle-less kitchen units as no handle is needed. For safety reasons, the door locks automatically when the machine is in use to avoid it being opened inadvertently.
-  **Air at 40°C** provides the perfect environment for proving yeast type dough mixes. Simply select the function and place dough in the cavity for allotted

 **SABBATH:** function that allows to cook food respecting Judaism's day of rest provisions.
-  **The oven cavity** has 5 different cooking levels.

 **Soft close:** all models are equipped with advanced function of smooth closing of the door, which allows the device to close smoothly and quietly.
-  **Electronic control:** Allows you to maintain temperature inside the oven with the precision 2-3 ° C. This enables to cook meals that are very sensitive to temperature changes, such as cakes, souffles, puddings.

 **Tilting grill:** the tilting grill can be easily unhooked to move the heating element and clean the roof of the appliance in one simple step.
-  **Ultra rapid burners:** Powerful ultra rapid burners offer up to 5kw of power.

 **Vapor Clean:** a simple cleaning function using steam to loosen deposits in the oven cavity.
-  **The capacity** indicates the amount of usable space in the oven cavity in litres.